

MAS-403 BT, CON CUERPO EQUILIBRADO, PARA FRESAS CILÍNDRICAS SEGÚN DIN 481, PARA FRESAS CON RANURA LONGITUDINAL DIN...

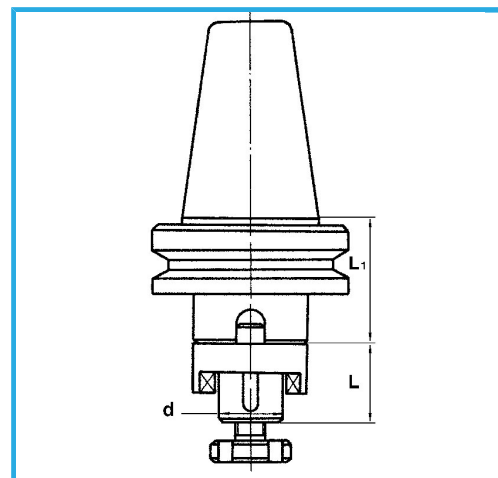

€189,00



Buril	50
d - h6	40 mm
L	41 mm
L1	40 mm
Peso bruto	4,18 kg
Codigo de barras	8012667008611



Caja



Templado



Rectificado



18Ni  
CrMo5