

DIN 2080, CON CUERPO EQUILIBRADO, PARA FRESAS CILÍNDRICAS
SEGÚN DIN 481, PARA FRESAS CON RANURA LONGITUDINAL DIN
1880...

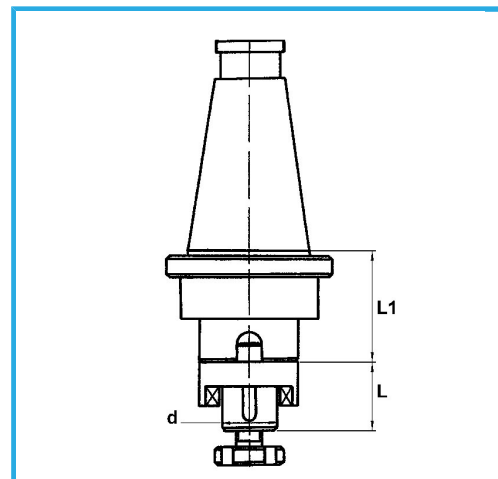

€158,00



ISO	50
d - h6	16 mm
L	27 mm
L1	35 mm
Peso bruto	4,16 kg
Codigo de barras	8012667008321



Caja



Rectificado

18Ni
CrMo5