

DIN 2080, CON CUERPO EQUILIBRADO, PARA FRESAS CILÍNDRICAS
SEGÚN DIN 481, PARA FRESAS CON RANURA LONGITUDINAL DIN
1880...

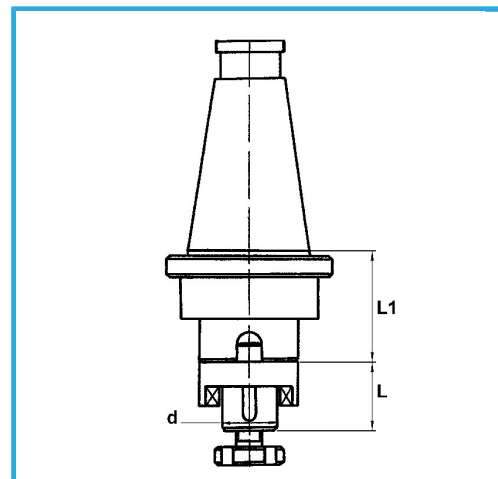

€131,00



ISO	40
d - h6	22 mm
L	31 mm
L1	39 mm
Peso bruto	1,53 kg
Codigo de barras	8012667008291



Caja



Rectificado



18Ni
CrMo5

-