

DIN 2080, CON CUERPO EQUILIBRADO, PARA FRESAS CILÍNDRICAS
SEGÚN DIN 481, PARA FRESAS CON RANURA LONGITUDINAL DIN
1880...

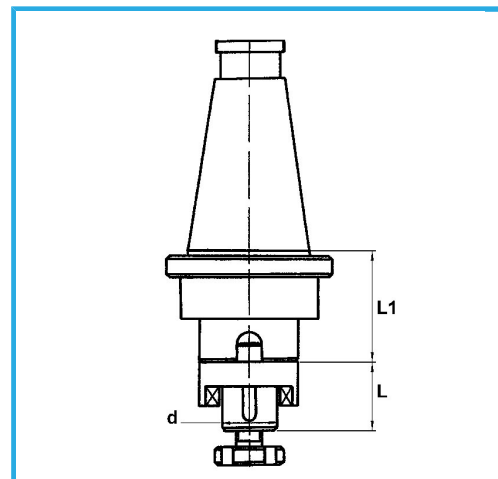

€158,00



ISO	50
d - h6	27 mm
L	33 mm
L1	35 mm
Peso bruto	3,57 kg
Codigo de barras	8012667008345



Caja



Rectificado



18Ni
CrMo5

-