

DIN 2080, CON CUERPO EQUILIBRADO, PARA FRESAS CILÍNDRICAS
SEGÚN DIN 481, PARA FRESAS CON RANURA LONGITUDINAL DIN
1880...

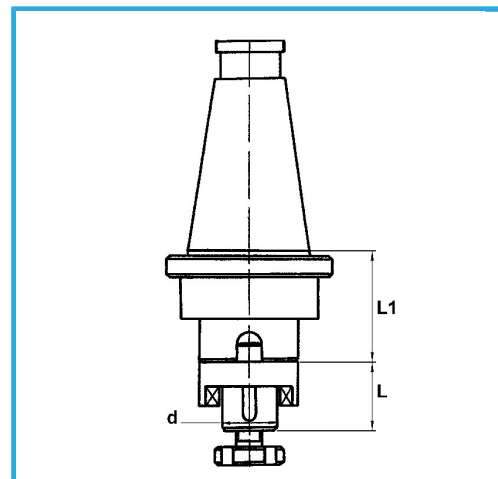

€131,00



ISO	40
d - h6	32 mm
L	38 mm
L1	40 mm
Peso bruto	2,45 kg
Codigo de barras	8012667008314



Caja



Rectificado

18Ni
CrMo5

-