

DIN 2080, CON CUERPO EQUILIBRADO, PARA FRESAS (WELDON)
SEGÚN DIN 1835 B Y DIN 6535 HB. SE SUMINISTRA CON TORNILLO
DE...

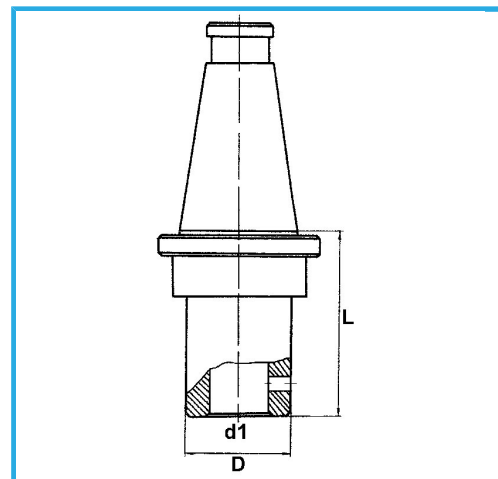

€129,00



ISO	40
d1 - h6	8 mm
D	28 mm
L	50 mm
Peso bruto	0,94 kg
Codigo de barras	8012667195878



Caja



Rectificado

18Ni
CrMo5