

DIN 2080, CON CUERPO EQUILIBRADO, PARA FRESAS (WELDON)  
SEGÚN DIN 1835 B Y DIN 6535 HB. SE SUMINISTRA CON TORNILLO  
DE...

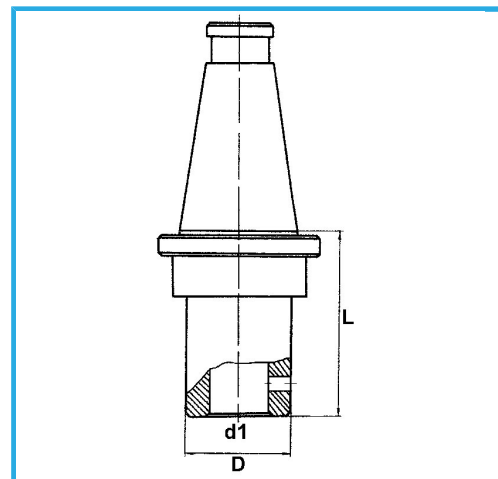

€140,00



ISO	50
d1 - h6	16 mm
D	48 mm
L	50 mm
Peso bruto	4,06 kg
Codigo de barras	8012667193188



Caja



Rectificado

18Ni  
CrMo5