

DIN 2080, CON CUERPO EQUILIBRADO, PARA FRESAS (WELDON)
SEGÚN DIN 1835 B Y DIN 6535 HB. SE SUMINISTRA CON TORNILLO
DE...

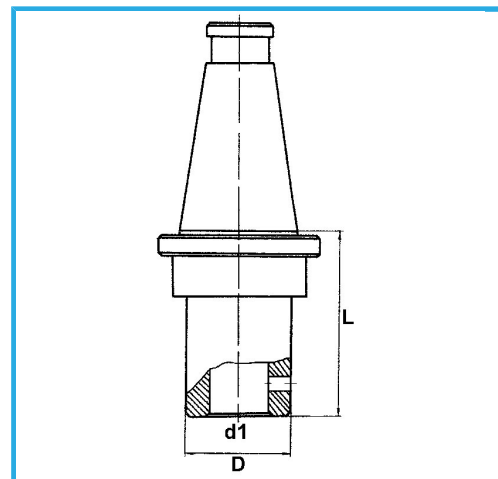

€154,00



ISO	50
d1 - h6	20 mm
D	52 mm
L	63 mm
Peso bruto	2,00 kg
Codigo de barras	8012667195465



Caja



Rectificado

18Ni
CrMo5