

DIN 2080, CON CUERPO EQUILIBRADO, PARA FRESAS (WELDON)
SEGÚN DIN 1835 B Y DIN 6535 HB. SE SUMINISTRA CON TORNILLO
DE...

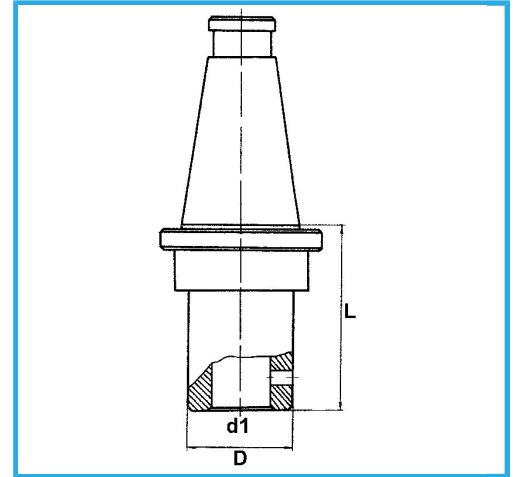

€129,00



ISO	40
d1 - h6	25 mm
D	65 mm
L	100 mm
Peso bruto	2,24 kg
Codigo de barras	8012667196028



Caja



Rectificado



18Ni
CrMo5