

DIN 2080, CON CUERPO EQUILIBRADO, PARA FRESAS (WELDON)
SEGÚN DIN 1835 B Y DIN 6535 HB. SE SUMINISTRA CON TORNILLO
DE...

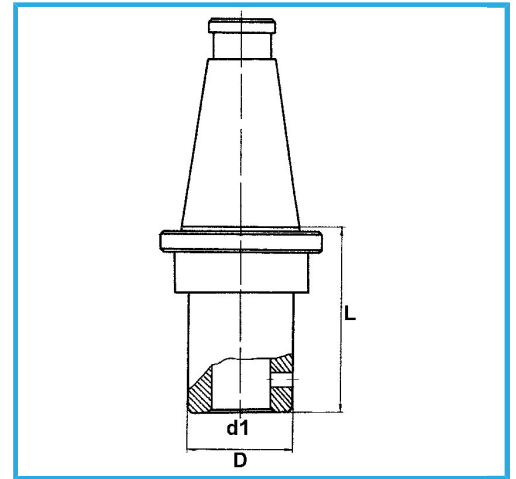

€166,00



ISO	50
d1 - h6	40 mm
D	90 mm
L	90 mm
Peso bruto	5,23 kg
Codigo de barras	8012667195472



Caja



Rectificado



18Ni
CrMo5