

DIN 2080, CON CUERPO EQUILIBRADO, PARA FRESAS CILÍNDRICAS  
SEGÚN DIN 481, PARA FRESAS CON RANURA LONGITUDINAL DIN  
1880...

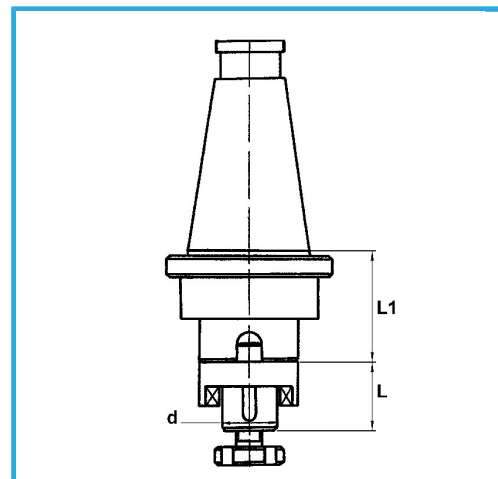

€182,00



ISO	50
d - h6	40 mm
L	41 mm
L1	40 mm
Peso bruto	5,20 kg
Codigo de barras	8012667008369



Caja



Rectificado

18Ni  
CrMo5

-