

€56,90

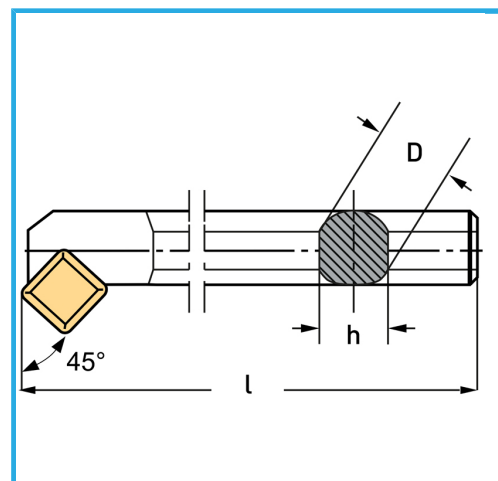

D	20 mm
h	18 mm
l	250 mm
Tornillo	KV400
Paqueta (no incluida)	SCMT09T3...
Peso bruto	0,59 kg
Codigo de barras	8012667255855

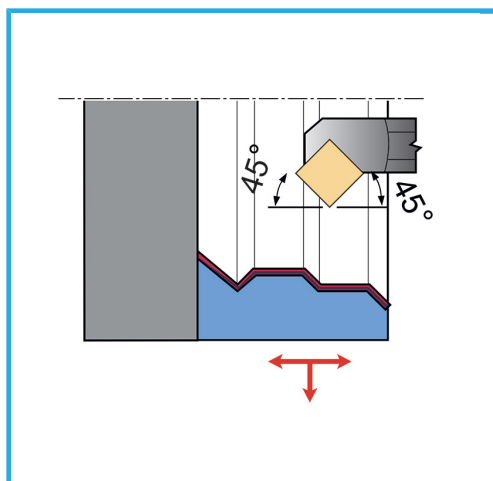

Caja



Satinado



Niquelada



Externa