

CONSTA DE UNA HERRAMIENTA DE ROSCADO INTERNO (1 PZ),
 TORNILLO M3,5 X 12MM DE REPUESTO (1 PZ), LLAVE HEXAGONAL DE
 2,5MM (1 PZ),...

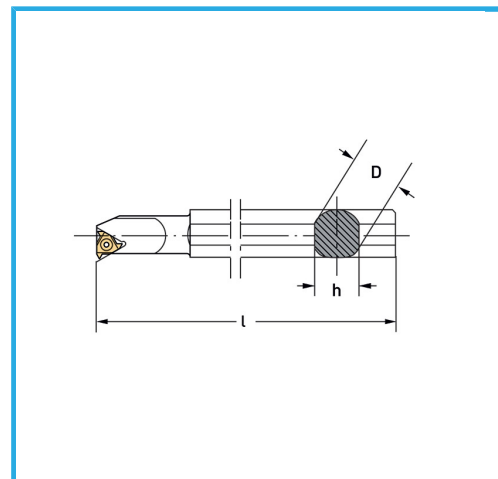

€216,00

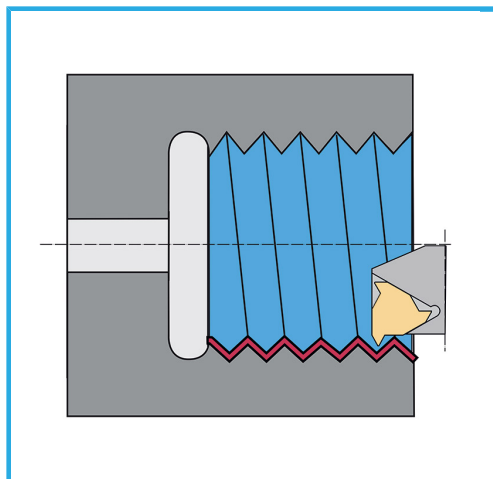

Herramientas para interior

Plaquita

Llave Torx

Tornillo

D

h

l

Peso bruto

Codigo de barras

SNR20

16IR...

T15

M3.5 x 12 mm

20 mm

18 mm

200 mm

0,87 kg

8012667252663



Satinado



Niquelada



Externa



15 Pcs



Estuche de
 transporte