

CONSISTING OF INTERNAL THREADING TOOL (1 PC), SPARE M3.5 X 12MM SCREW (1 PC), 2.5MM HEX WRENCH (1 PC), T15 TORX WRENCH (1 PC)...

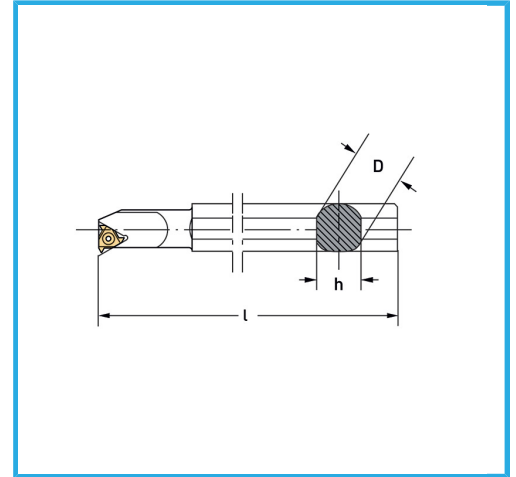
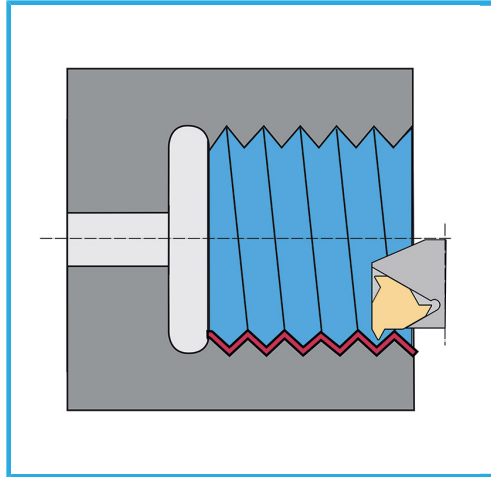

Int. tool holder

Insert

Torx key

Screw

D

h

l

Gross weight

EAN Code

SNR25

16IR...

T15

M3.5 x 12 mm

25 mm

23 mm

200 mm

1,15 kg

8012667260620



Satin



Nickel plated



External



15 Pcs



Carrying case