

CON CONEXIÓN DE MANGUITO, RECOMENDADO PARA USO EN MÁQUINAS CON POTENCIA MEDIA.

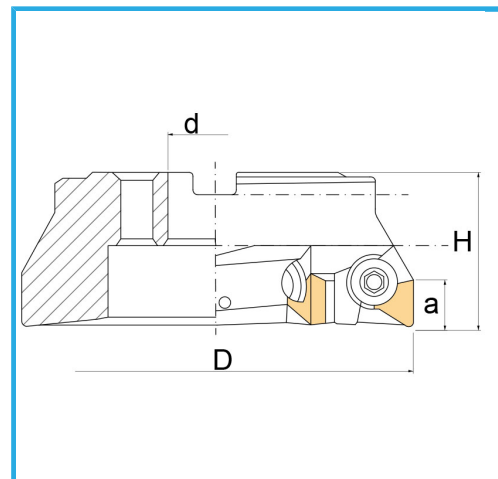

€172,00

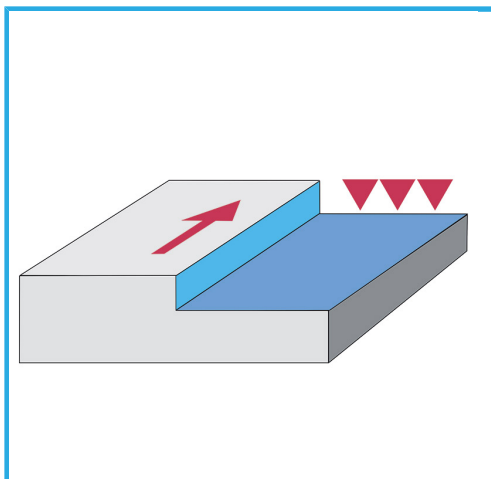

D	63 mm
H	40 mm
a	16 mm
d	22 mm
Z	3
Tornillo	F256/644
Paquita (no incluida)	TPKN1603...
Peso bruto	0,51 kg
Codigo de barras	8012667189877



Caja



Satinado



Niquelada



Interna