

CON CONEXIÓN DE MANGUITO, RECOMENDADO PARA USO EN MÁQUINAS CON POTENCIA MEDIA.

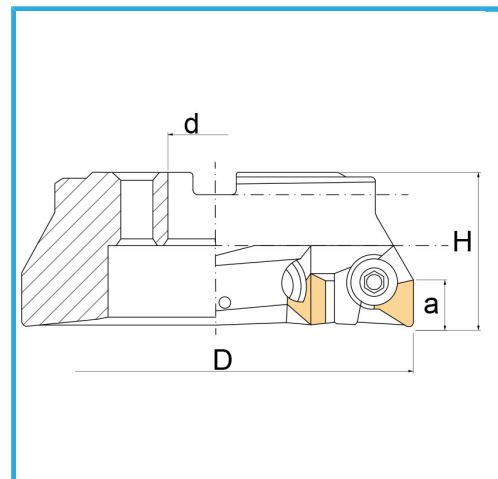

€176,00

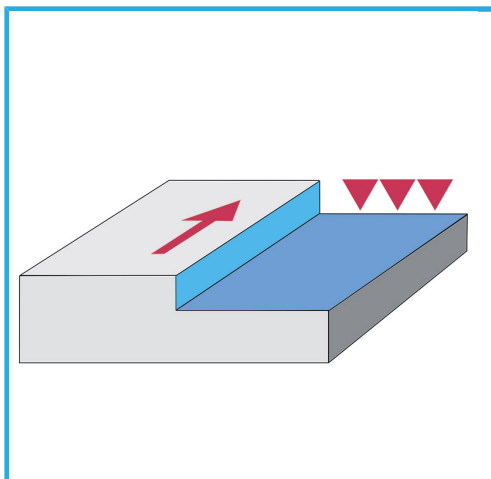

D	80 mm
H	50 mm
a	22 mm
d	27 mm
Z	4
Tornillo	F256/648
Paquita (no incluida)	TPKN2204...
Peso bruto	0,94 kg
Codigo de barras	8012667189884



Caja



Satinado



Niquelada



Interna