

CON CONEXIÓN DE MANGUITO, RECOMENDADO PARA USO EN MÁQUINAS CON POTENCIA MEDIA.

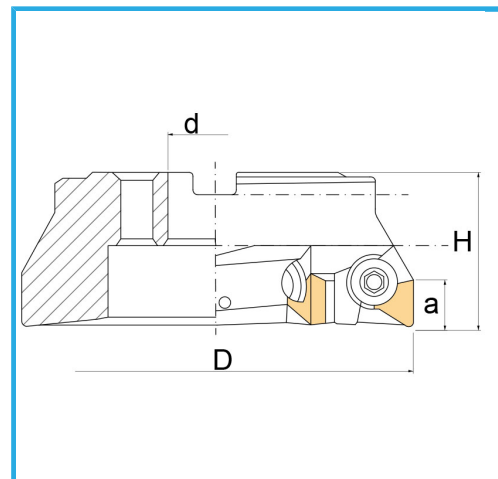

€228,00

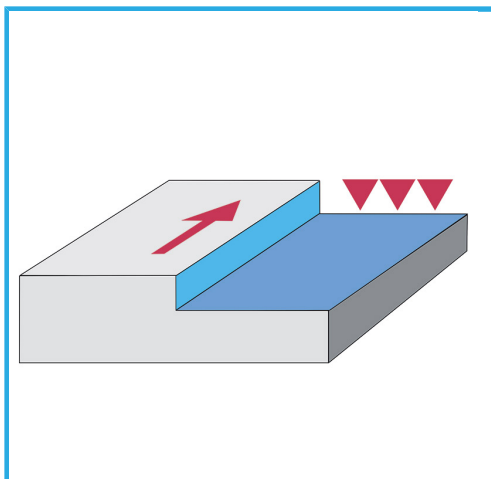

D	100 mm
H	50 mm
a	22 mm
d	32 mm
Z	5
Tornillo	F256/648
Paquita (no incluida)	TPKN2204...
Peso bruto	1,48 kg
Codigo de barras	8012667182861



Caja



Satinado



Niquelada



Interna