

CON CONEXIÓN DE MANGUITO, RECOMENDADO PARA USO EN MÁQUINAS CON POTENCIA MEDIA.

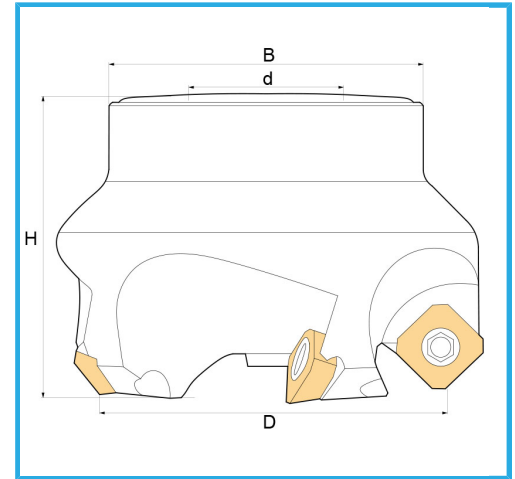

€121,00

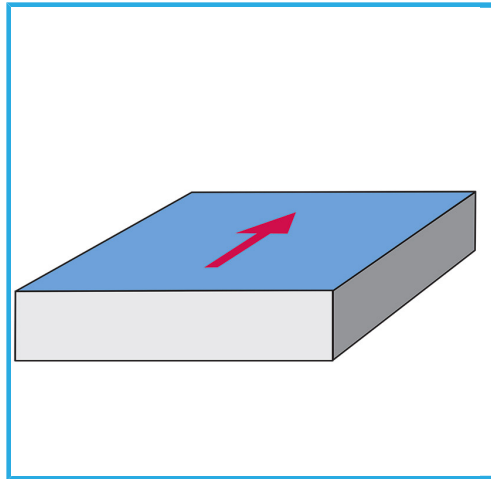

D	40 mm
H	45 mm
B	53 mm
d	16 mm
Z	3
Tornillos	KV500
Paquita (no incluida)	SEHX1204... / SEHT1204...
Peso bruto	0,50 kg
Codigo de barras	8012667180966



Caja



Satinado



Niquelada



Externa