

CON CONEXIÓN DE MANGUITO, RECOMENDADO PARA USO EN MÁQUINAS CON POTENCIA MEDIA.

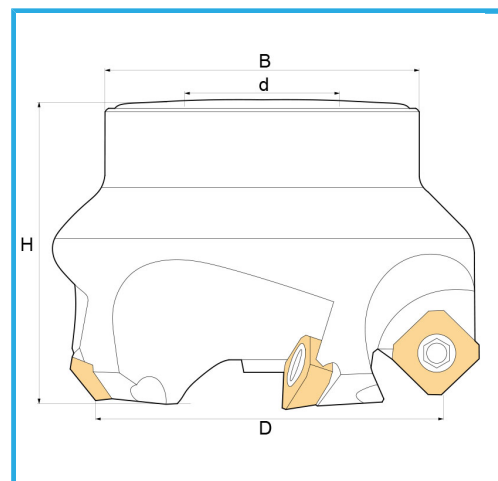

€224,00

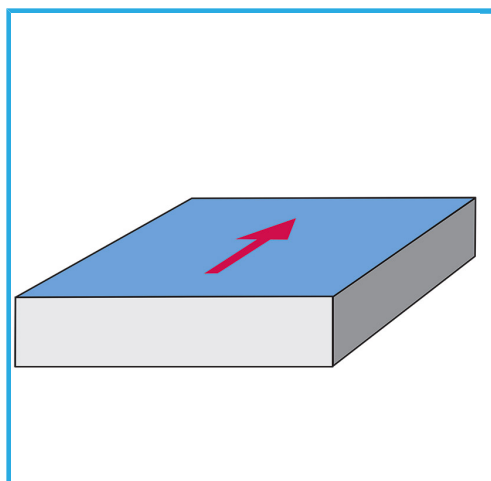

D	100 mm
H	50 mm
B	113 mm
d	32 mm
Z	6
Tornillos	KV500
Paquita (no incluida)	SEHX1204... / SEHT1204...
Peso bruto	2,03 kg
Codigo de barras	8012667181406



Caja



Satinado



Niquelada



Externa