

WITH SLEEVE CONNECTION, RECOMMENDED FOR USE ON MACHINES WITH REDUCED POWER.

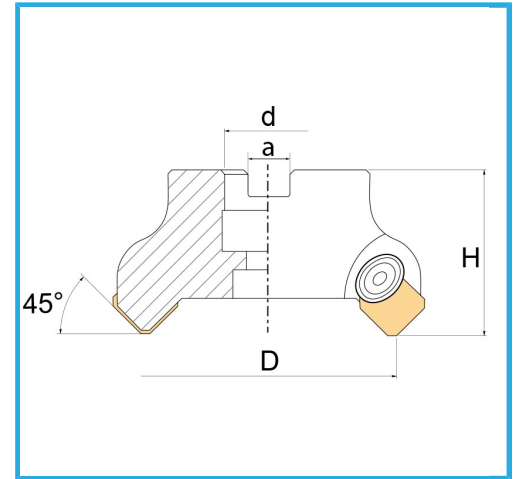

D	100 mm
H	50mm
a	16,4 mm
d	32 mm
Z	6
Screw	VT00440
Insert base	WSSP
Insert (not included)	SEKN1203...
Gross weight	2,05 kg
EAN Code	8012667253219

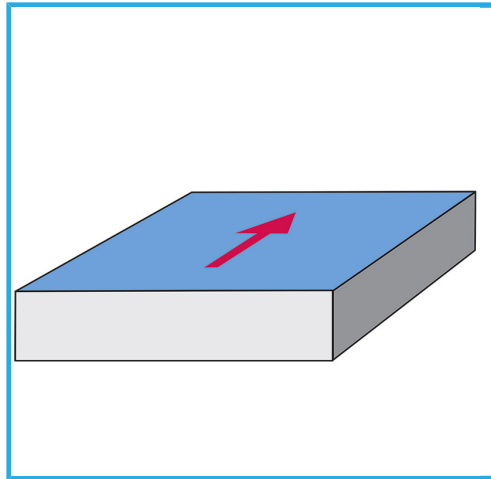

Box



Satin



Nickel
plated



External