

CON CONEXIÓN DE MANGUITO, RECOMENDADO PARA USO EN MÁQUINAS CON POTENCIA REDUCIDA.

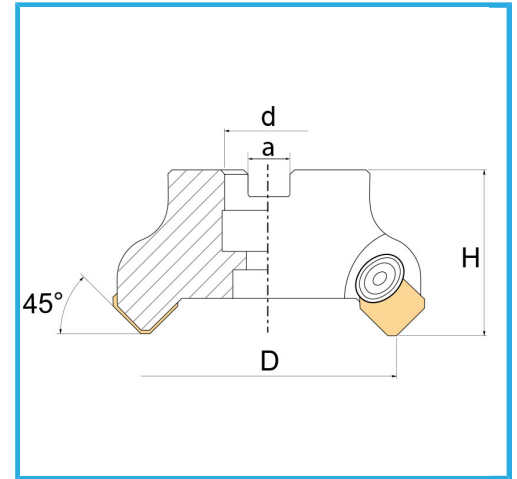

€154,00

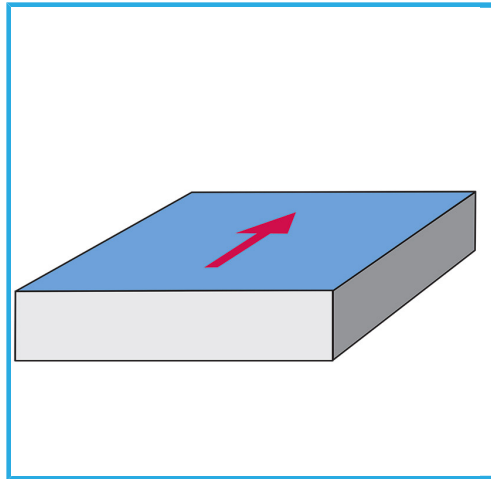

D	40 mm
H	48 mm
a	8,4 mm
d	16 mm
Z	3
Tornillo	VT00440
Base de plaquita	WSSP
Plaquita (no incluida)	SEKN1203...
Peso bruto	0,45 kg
Codigo de barras	8012667253172



Caja



Satinado



Niquelada



Externa