

CON CONEXIÓN DE MANGUITO, RECOMENDADO PARA USO EN MÁQUINAS CON POTENCIA REDUCIDA.

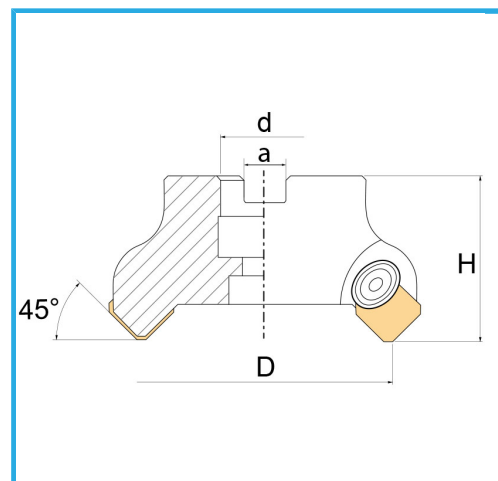

€161,00

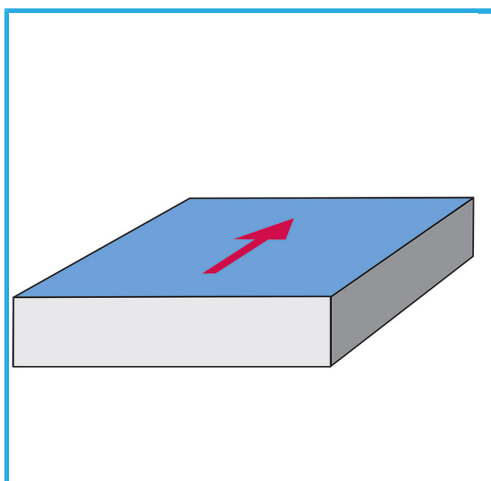

D	50 mm
H	48 mm
a	10,4 mm
d	22 mm
Z	4
Tornillo	VT00440
Base de plaquita	WSSP
Plaquita (no incluida)	SEKN1203...
Peso bruto	0,59 kg
Codigo de barras	8012667253189



Caja



Satinado



Niquelada



Externa