

WITH SLEEVE CONNECTION, RECOMMENDED FOR USE ON MACHINES WITH REDUCED POWER.

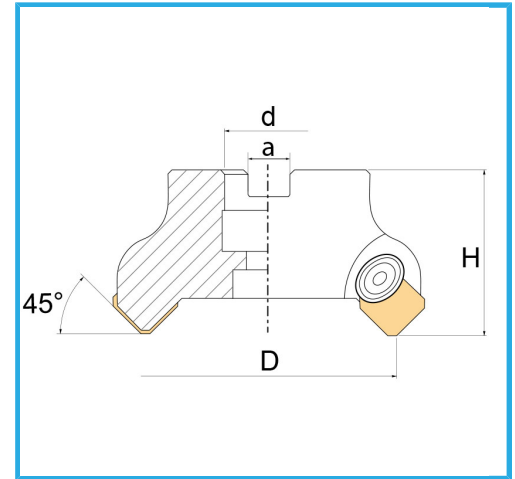

D	80 mm
H	50 mm
a	14,4 mm
d	27 mm
Z	5
Screw	VT00440
Insert base	WSSP
Insert (not included)	SEKN1203...
Gross weight	1,16 kg
EAN Code	8012667253202

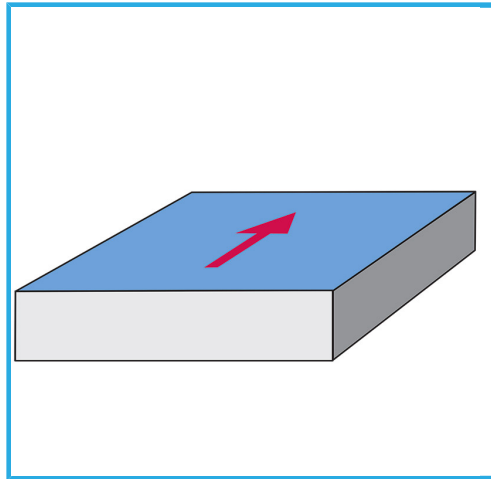

Box



Satin



Nickel
plated



External