

POSITIVE.

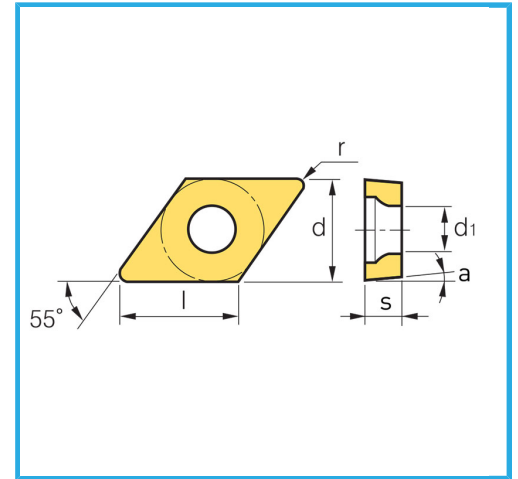

Dimensions	11 mm
d	9.52 mm
l	11.60 mm
s	3.97 mm
r	0.40 mm
d1	2.20 mm
a°	7°
Pack	10
Gross weight	0,06 kg
EAN Code	8012667011284



Box



-