

POSITIVA.

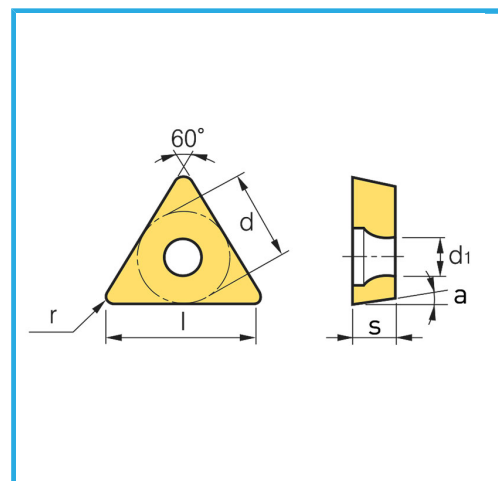

€7,40



Dimensioni	9 mm
d	3.40 mm
l	9.63 mm
s	2.38 mm
r	0.40 mm
d1	2.50 mm
a°	7°
Pack	10
Peso lordo	0,02 kg
Codice EAN	8012667234317



Scatola



-