

POSITIVA.

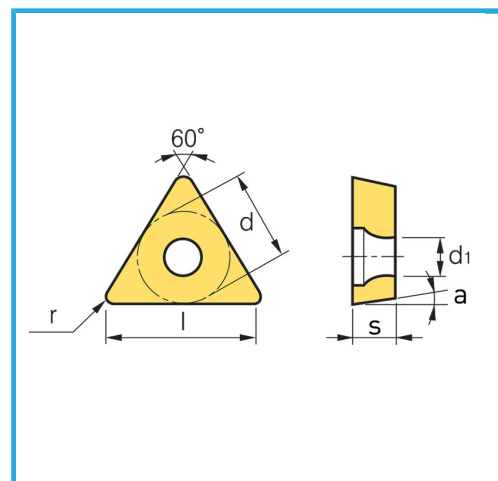

€9,80



Dimensioni	16 mm
d	9.52 mm
l	16.50 mm
s	3.97 mm
r	0.40 mm
d1	4.40 mm
a°	7°
Pack	10
Peso lordo	0,06 kg
Codice EAN	8012667007164



Scatola



-