

€9,20

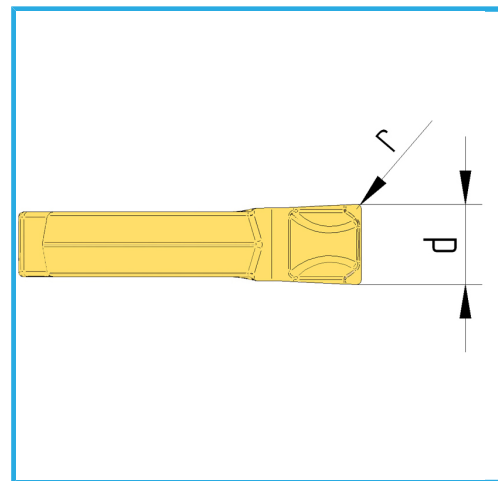

d	2.20 mm
r	0.20 mm
Pack	10
Peso lordo	0,00 kg
Codice EAN	8012667200695

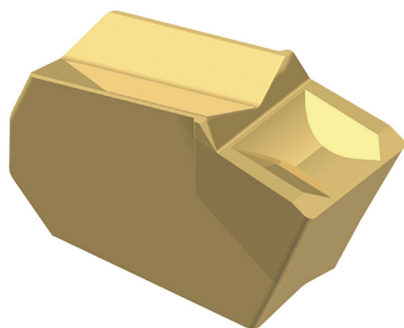

Scatola



-