

ISO 6

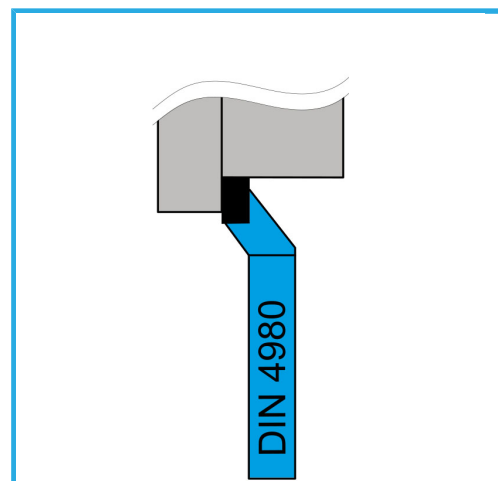

€8,30

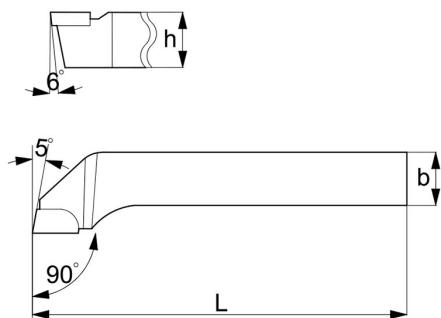

L	110 mm
b	16 mm
h	16 mm
Peso bruto	0,21 kg
Codigo de barras	8012667008703

HM
P25



4980