

REGULAR LENGTH WELDON SHANK CENTER CUTTING.

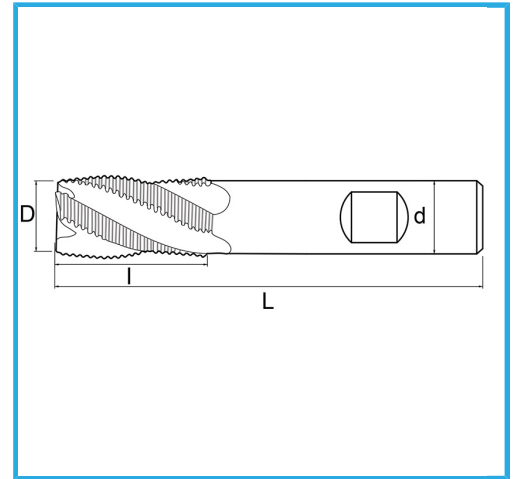

D	7 mm
d	10 mm
l	16 mm
Z	4
L	66 mm
Gross weight	0,03 kg
EAN Code	8012667237868



Box



External



844/B



HSS

-



TIN

-