

REGULAR LENGTH WELDON SHANK CENTER CUTTING.

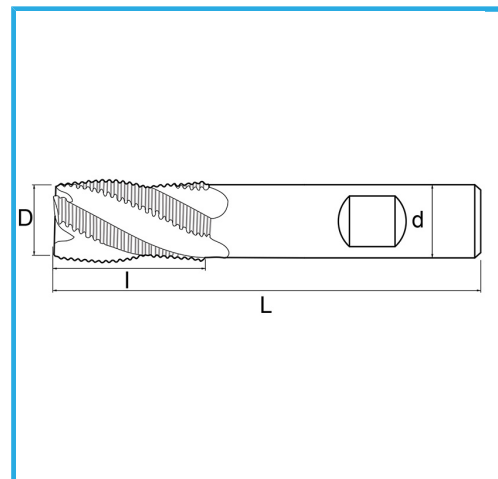

D	16 mm
d	16 mm
l	32 mm
Z	4
L	92 mm
Gross weight	0,13 kg
EAN Code	8012667217341



Box



External



844/B



HSS

-



TIN

-