

WITH GROUND EDGES AND GROOVES MACHINED FROM SOLID, TO PERFORM CONICAL COUNTERSINKS WITHOUT VIBRATIONS.

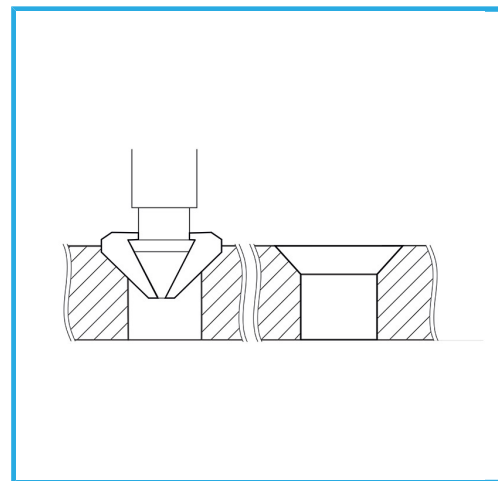

Ø max	10,4 mm
Screws M	5
Shank	Ø 6 mm
Gross weight	0,01 kg
EAN Code	8012667142216

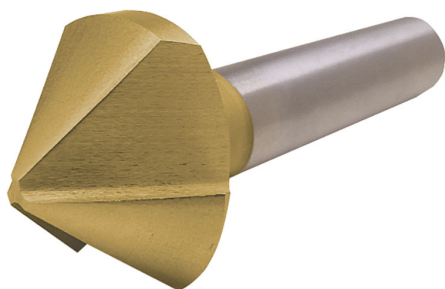

Box



HSS

-



TiN

-



90°



External