

ART. S010
AVELLANADOR CONICO 90° DE MANGO CILINDRICO
ANTIVIBRACION



CON CANTOS RECTIFICADOS Y RANURAS MECANIZADAS EN MACIZO,
PARA REALIZAR AVELLANADOS CÓNICOS SIN VIBRACIONES.



€12,60

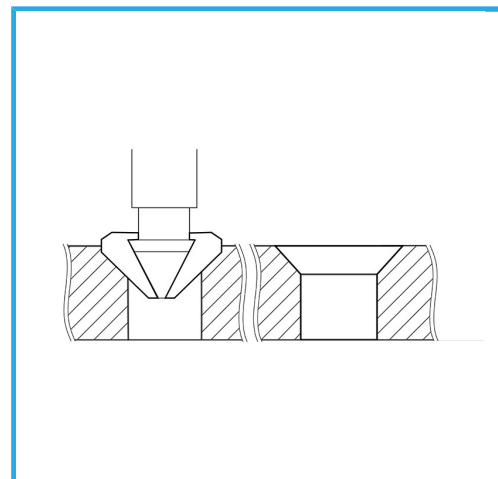
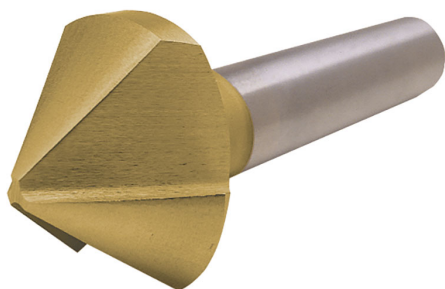

Ø max	10,4 mm
Para tornillos M	5
Eje	Ø 6 mm
Peso bruto	0,01 kg
Codigo de barras	8012667142216



Caja



HSS

-



TiN

-



90°



Externa