

ART. S016
AVELLANADOR CONICO 90° DE MANGO CILINDRICO
ANTIVIBRACION



CON CANTOS RECTIFICADOS Y RANURAS MECANIZADAS EN MACIZO,
PARA REALIZAR AVELLANADOS CÓNICOS SIN VIBRACIONES.



€18,80

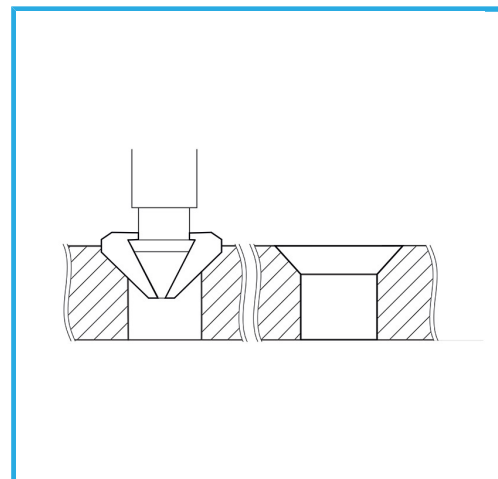
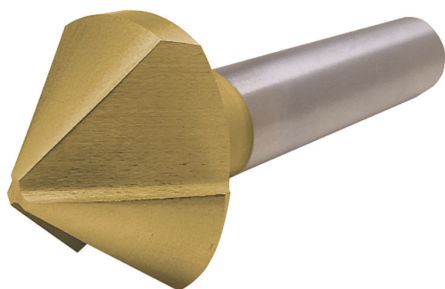

Ø max	16,5 mm
Para tornillos M	8
Eje	Ø 10 mm
Peso bruto	0,04 kg
Codigo de barras	8012667142223



Caja



HSS

-



TiN

-



90°



Externa