

ART. S025
AVELLANADOR CONICO 90° DE MANGO CILINDRICO
ANTIVIBRACION



CON CANTOS RECTIFICADOS Y RANURAS MECANIZADAS EN MACIZO,
PARA REALIZAR AVELLANADOS CÓNICOS SIN VIBRACIONES.



€27,50

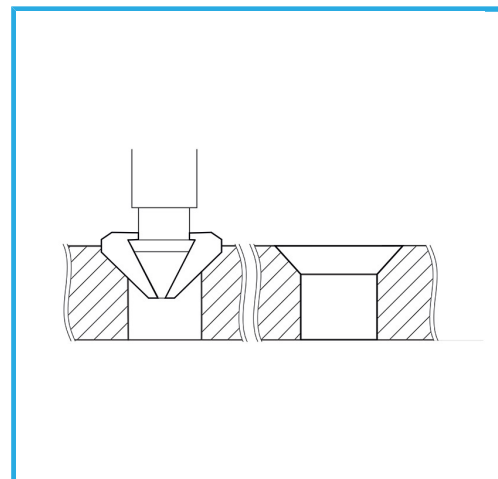
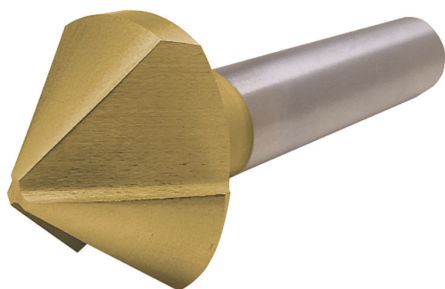

Ø max	25 mm
Para tornillos M	12
Eje	Ø 10 mm
Peso bruto	0,07 kg
Codigo de barras	8012667142247



Caja



HSS

-



TiN

-



90°



Externa