

WITH GROUND EDGES AND GROOVES MACHINED FROM SOLID, TO PERFORM CONICAL COUNTERSINKS WITHOUT VIBRATIONS.

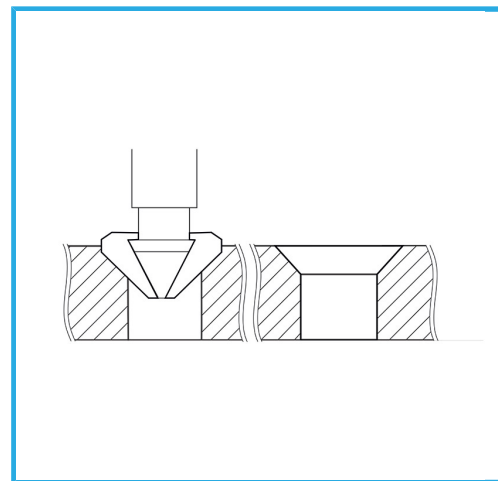

Ø max	31 mm
Screws M	16
Shank	Ø 12 mm
Gross weight	0,12 kg
EAN Code	8012667142261

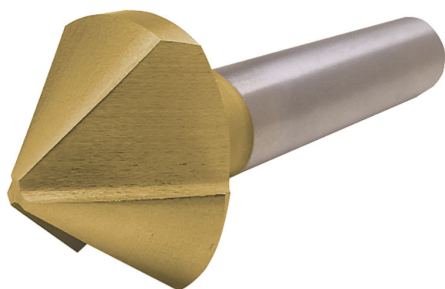

Box



HSS

-



TiN

-



90°



External