

ART. M001/04V
MACHINE TAPS STRAIGHT FLUTE, SPIRAL POINTED FOR THROUGH HOLES

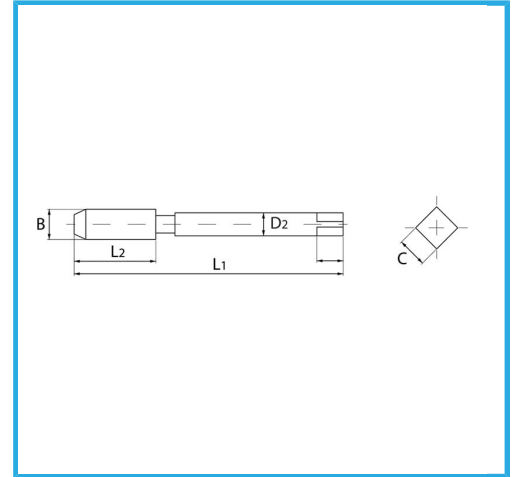

ISOMETRIC THREAD COARSE PITCH - REINFORCED SHANK, THE VAPORIZATION TREATMENT INCREASES THE SURFACE HARDNESS AND WEAR RESISTANCE...

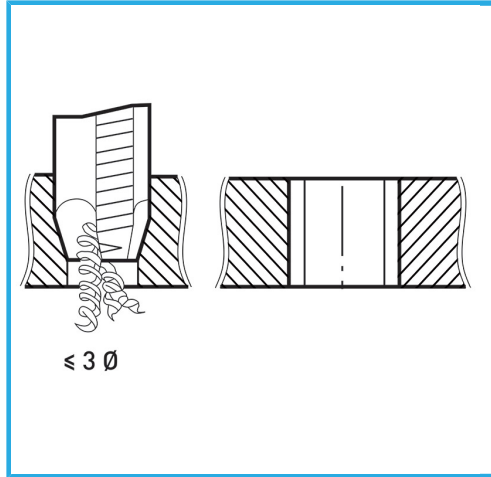

B	M4 x 0,70 mm
L2	13 mm
L1	63 mm
D2	4.5 mm
C	3.4 mm
Gross weight	0,01 kg
EAN Code	8012667257354



Box



HSS-G



Vaporized



HV=750



External



371/B