

ART. M003/04V

MACHOS DE MÁQUINA CON RANURAS HELICOIDALES DE 35° A LA DERECHA PARA AGUJEROS CIEGOS



PASO GRUESO DE HILO ISOMÉTRICO - VÁSTAGO REFORZADO, EL TRATAMIENTO DE VAPORIZACIÓN AUMENTA LA DUREZA DE LA...



€7,70

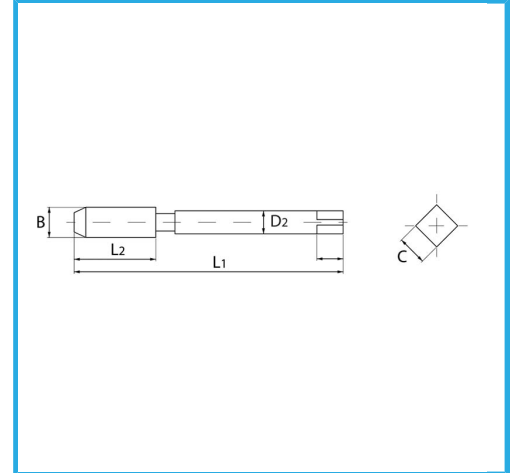
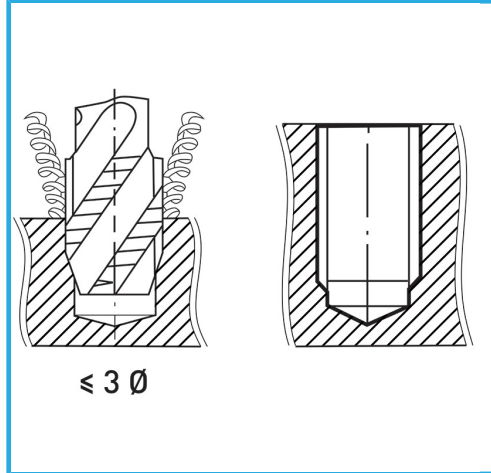

B	M4 x 0,70 mm
L2	13 mm
L1	63 mm
D2	4.5 mm
C	3.4 mm
Peso bruto	0,01 kg
Dimensiones de embalaje	70x11x11 h mm
Codigo de barras	8012667257248



Caja



HSS-G



Vaporizado



HV=750



Externa



371/C