

ISOMETRIC THREAD COARSE PITCH - REINFORCED SHANK, THE VAPORIZATION TREATMENT INCREASES THE SURFACE HARDNESS AND WEAR RESISTANCE...

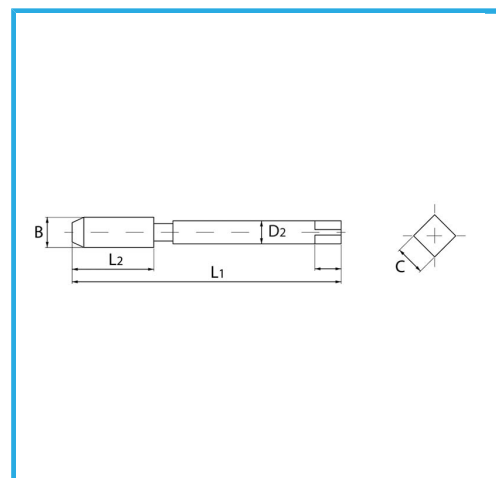

B	M10 x 1,5 mm
L2	24 mm
L1	100 mm
D2	10 mm
C	8 mm
Gross weight	0,05 kg
EAN Code	8012667257279

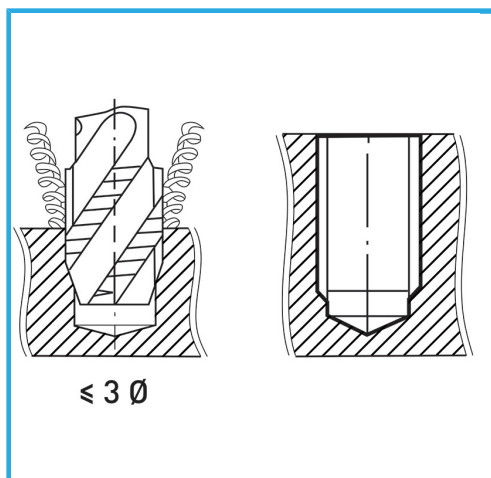

Box



HSS-G

-



Vaporized



HV=750



External



371/C