

ART. M003/10V

MACHOS DE MÁQUINA CON RANURAS HELICOIDALES DE 35° A LA DERECHA PARA AGUJEROS CIEGOS



PASO GRUESO DE HILO ISOMÉTRICO - VÁSTAGO REFORZADO, EL TRATAMIENTO DE VAPORIZACIÓN AUMENTA LA DUREZA DE LA...



€15,00

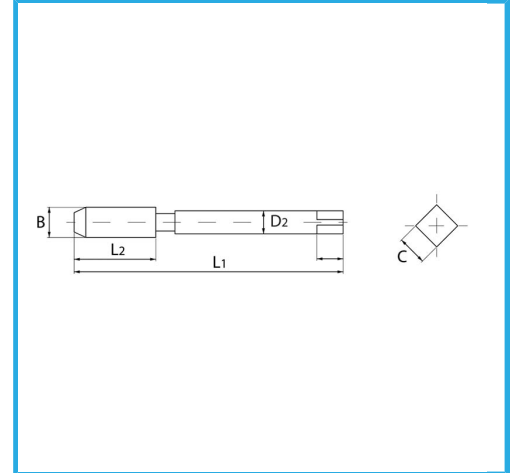
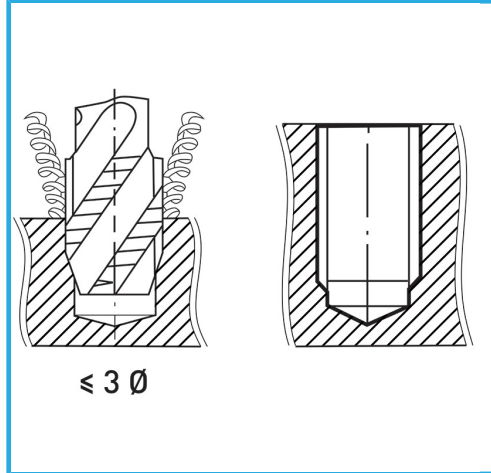

B	M10 x 1,5 mm
L2	24 mm
L1	100 mm
D2	10 mm
C	8 mm
Peso bruto	0,05 kg
Codigo de barras	8012667257279



Caja



HSS-G



Vaporizado



HV=750



Externa



371/C