

ART. M003/12

MACHOS DE MÁQUINA CON RANURAS HELICOIDALES DE 35° A LA DERECHA PARA AGUJEROS CIEGOS



PASO GRUESO DE HILO ISOMÉTRICO.



€14,00

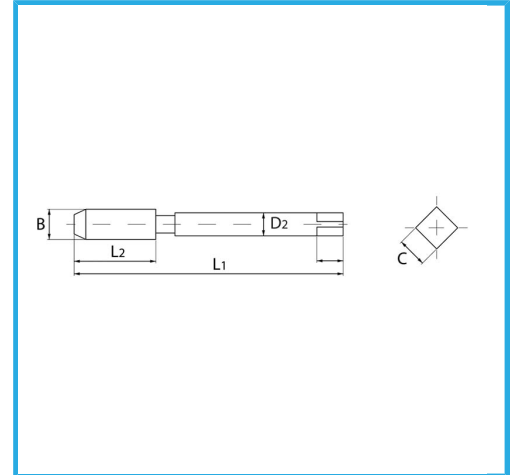
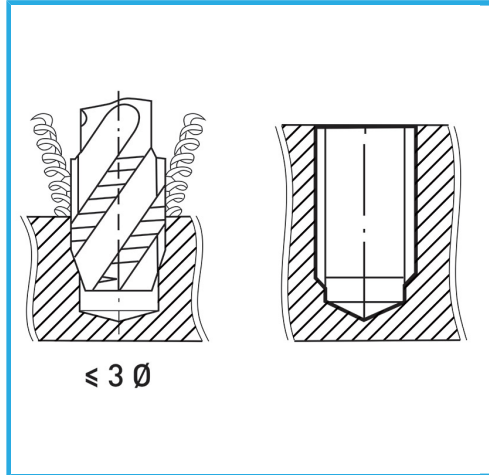

B	M12 x 1,75 mm
L2	29 mm
L1	110 mm
D2	9 mm
C	7 mm
Peso bruto	0,05 kg
Codigo de barras	8012667141714



Caja



HV=750



Externa



376/C



HSS-G

-