

ART. M003/12V

MACHOS DE MÁQUINA CON RANURAS HELICOIDALES DE 35° A LA DERECHA PARA AGUJEROS CIEGOS



PASO GRUESO DE HILO ISOMÉTRICO - VÁSTAGO REFORZADO, EL TRATAMIENTO DE VAPORIZACIÓN AUMENTA LA DUREZA DE LA...



€17,70

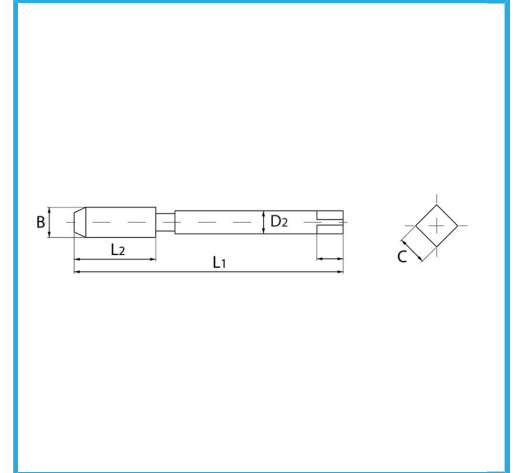
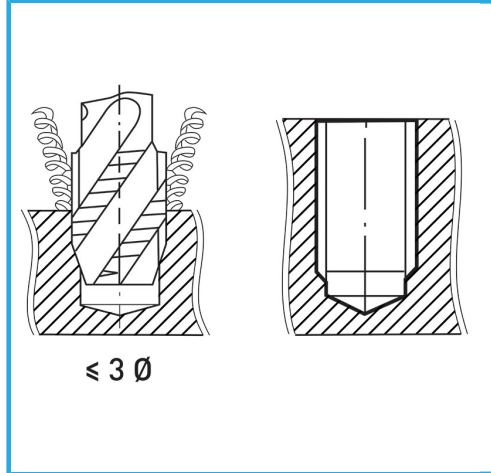

B	M12 x 1,75 mm
L2	29 mm
L1	110 mm
D2	9 mm
C	7 mm
Peso bruto	0,06 kg
Codigo de barras	8012667257286



Caja



HSS-G



Vaporizado



HV=750



Externa



376/C