

ART. M003/14

MACHOS DE MÁQUINA CON RANURAS HELICOIDALES DE 35° A LA DERECHA PARA AGUJEROS CIEGOS



PASO GRUESO DE HILO ISOMÉTRICO.



€17,70

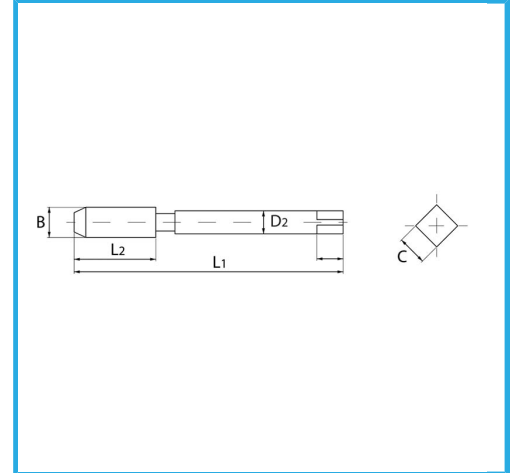
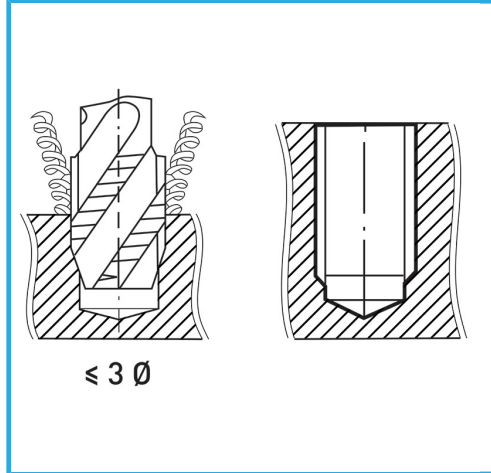

B	M14 x 2 mm
L2	30 mm
L1	110 mm
D2	11 mm
C	9 mm
Peso bruto	0,05 kg
Codigo de barras	8012667141721



Caja



HV=750



Externa



376/C



HSS-G

-