

ART. M003/16

MACHOS DE MÁQUINA CON RANURAS HELICOIDALES DE 35° A LA DERECHA PARA AGUJEROS CIEGOS



PASO GRUESO DE HILO ISOMÉTRICO.



€20,40

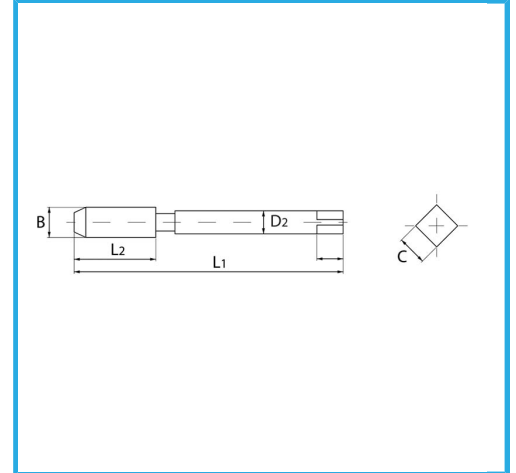
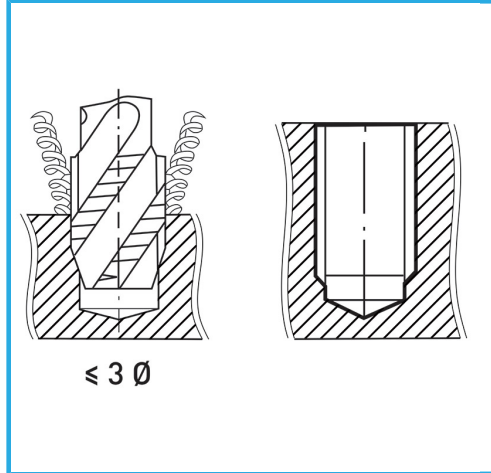

B	M16 x 2 mm
L2	32 mm
L1	110 mm
D2	12 mm
C	9 mm
Peso bruto	0,10 kg
Codigo de barras	8012667141738



Caja



HV=750



Externa



376/C



HSS-G

-