

ART. M003/20

MACHOS DE MÁQUINA CON RANURAS HELICOIDALES DE 35° A LA DERECHA PARA AGUJEROS CIEGOS



PASO GRUESO DE HILO ISOMÉTRICO.



€36,40

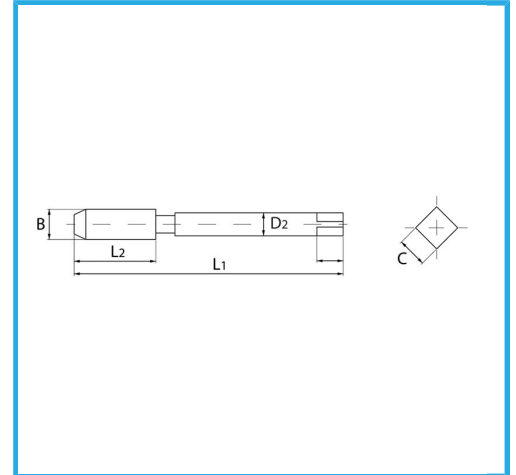
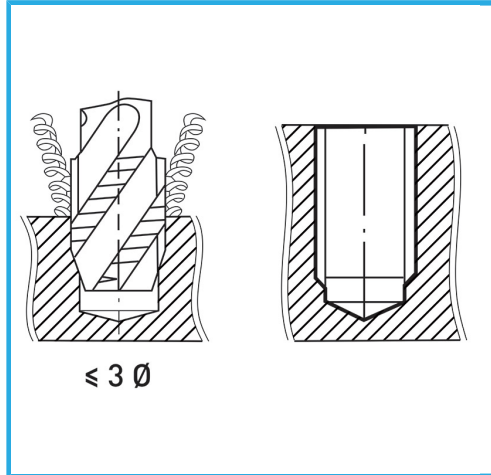

B	M20 x 2,5 mm
L2	34 mm
L1	140 mm
D2	16 mm
C	12 mm
Peso bruto	0,05 kg
Codigo de barras	8012667141752



Caja



HV=750



Externa



376/C



HSS-G

-