

ART. M003/20V

MACHOS DE MÁQUINA CON RANURAS HELICOIDALES DE 35° A LA DERECHA PARA AGUJEROS CIEGOS



PASO GRUESO DE HILO ISOMÉTRICO - VÁSTAGO REFORZADO, EL TRATAMIENTO DE VAPORIZACIÓN AUMENTA LA DUREZA DE LA...



€40,70

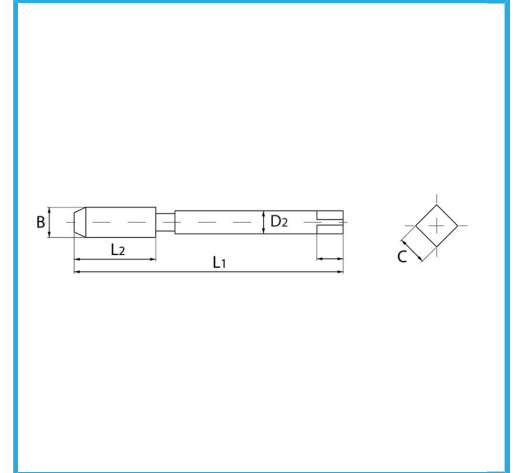
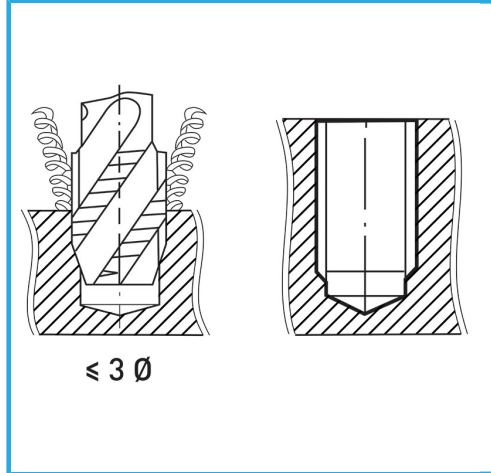

B	M20 x 2,5 mm
L2	34 mm
L1	140 mm
D2	16 mm
C	12 mm
Peso bruto	0,23 kg
Codigo de barras	8012667257330



Caja



HSS-G



Vaporizado



HV=750



Externa



376/C