

SUITABLE FOR THREAD REGENERATION OR TO OBTAIN VERY RESISTANT TAPPING IN SOFT MATERIALS.

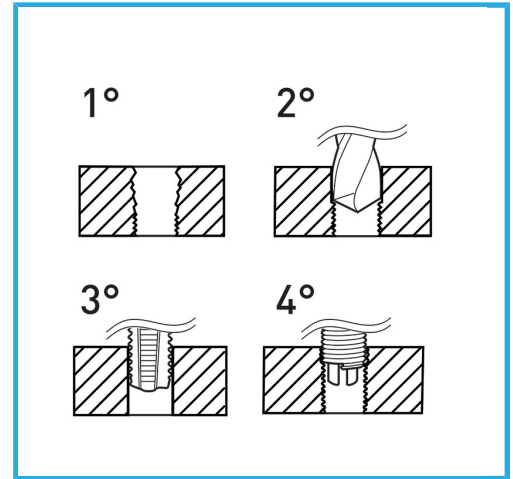

Thread insert	M5
Drill	5,2 mm
Tap	x M5
Handle	2
Gross weight	0,41 kg
EAN Code	8012667249939



Hangable

HSS



INOX