

INDICADO PARA LA REGENERACIÓN DE ROSCAS O PARA OBTENER ROSCADOS MUY RESISTENTES EN MATERIALES BLANDOS.

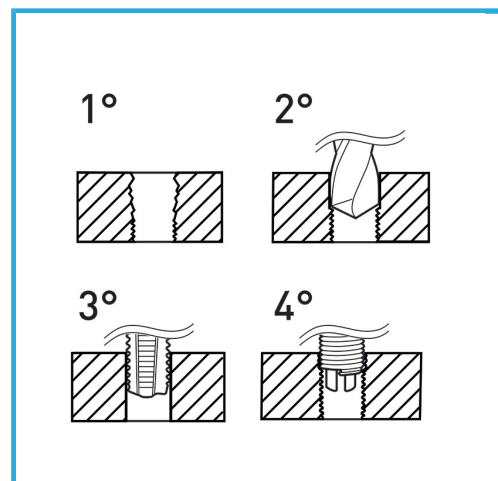

€34,00



Rosca inserta	M8
Broca	8,3 mm
Macho	x M8
Mango	2
Peso bruto	0,53 kg
Codigo de barras	8012667249953



Colgante

HSS



INOX