

SUITABLE FOR THREAD REGENERATION OR TO OBTAIN VERY RESISTANT TAPPING IN SOFT MATERIALS.

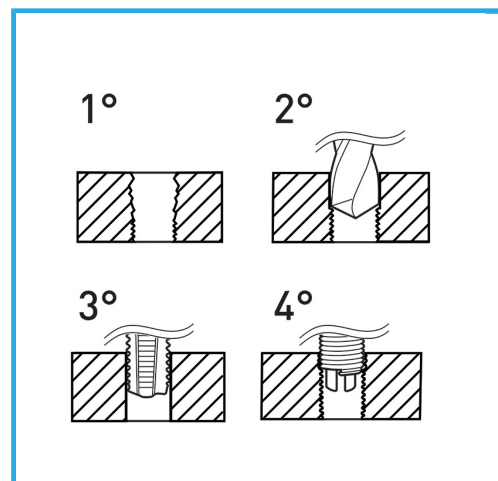

Thread insert	M10
Drill	10,4 mm
Tap	x M10
Handle	2
Gross weight	0,58 kg
EAN Code	8012667249960



Hangable

HSS

INOX