

ART. 0855/T25

TWO WAY TORX AND TAMPERED KEY WITH ANATOMIC PLASTIC HANDLE

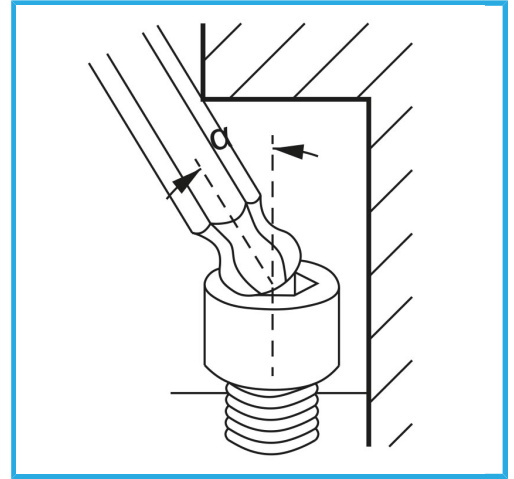

Size	T25
Length	100 mm
Gross weight	0,04 kg
EAN Code	8012667187019



Hangable



Chromed



-



-